

1

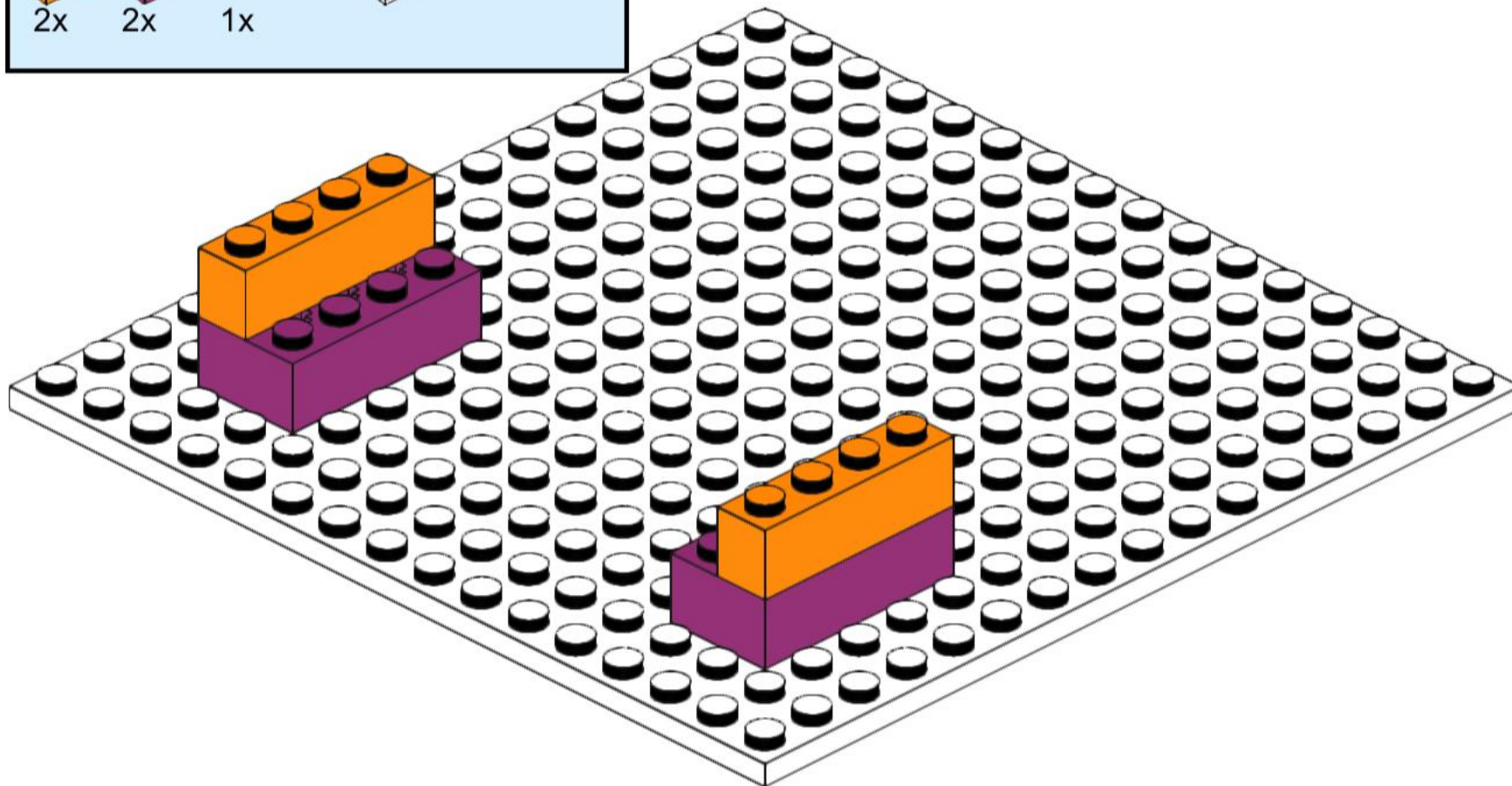

2

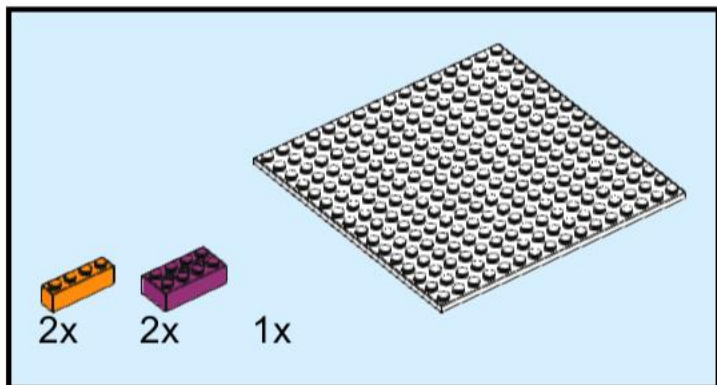
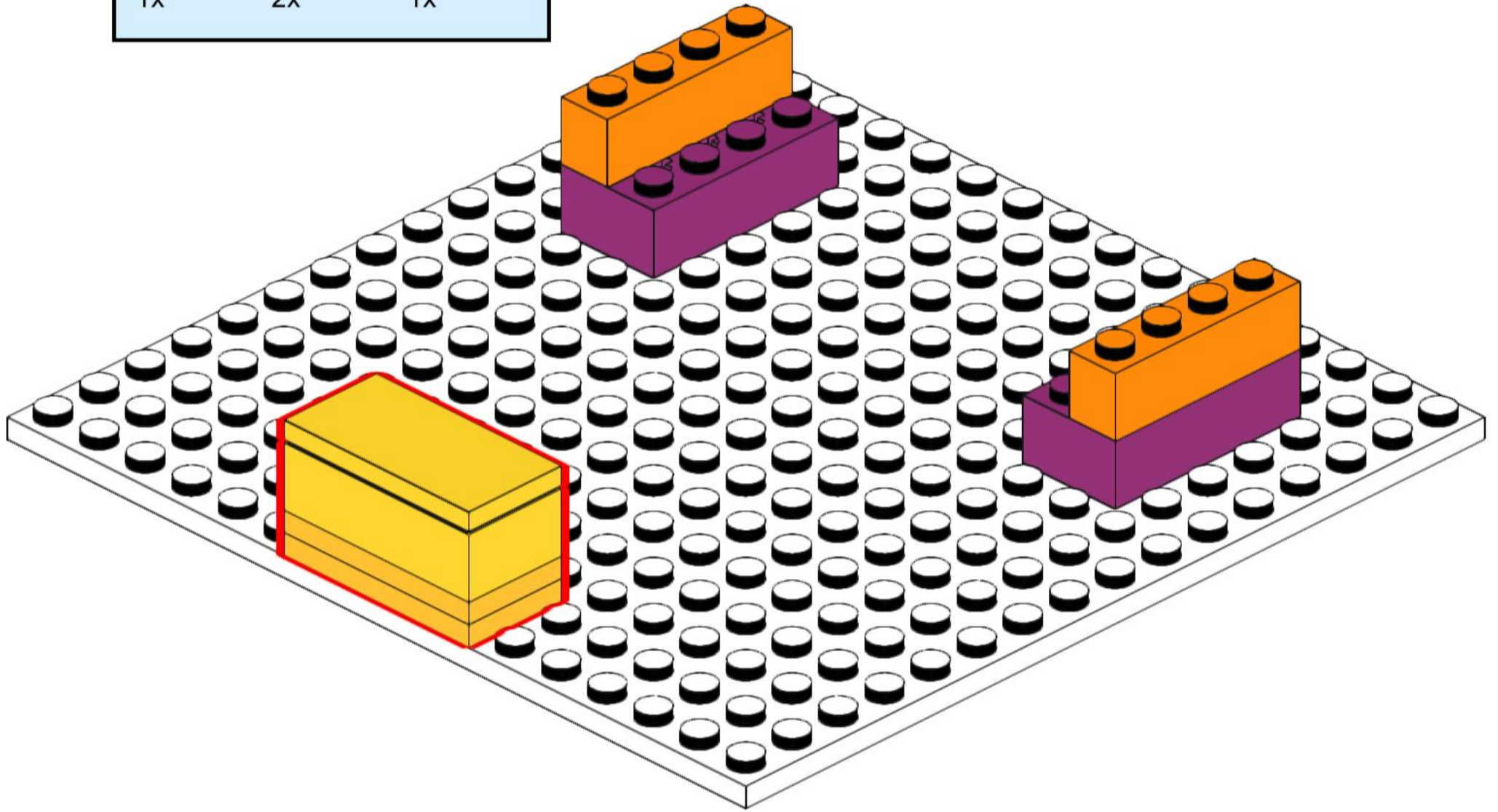
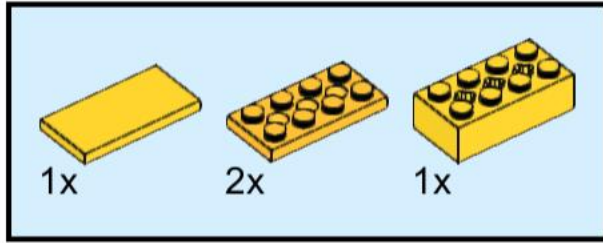

3

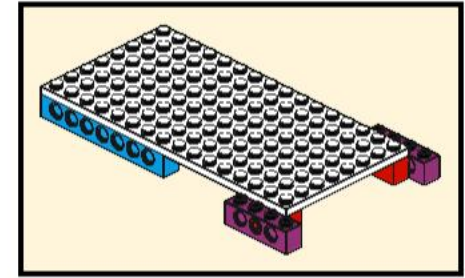
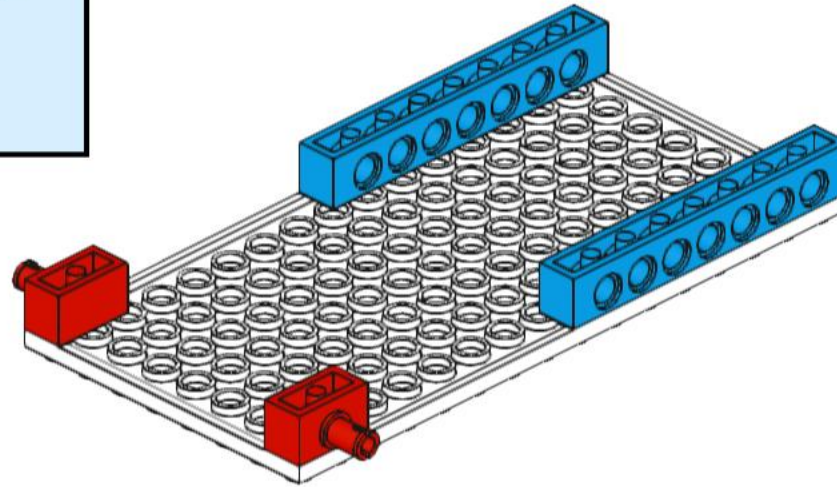
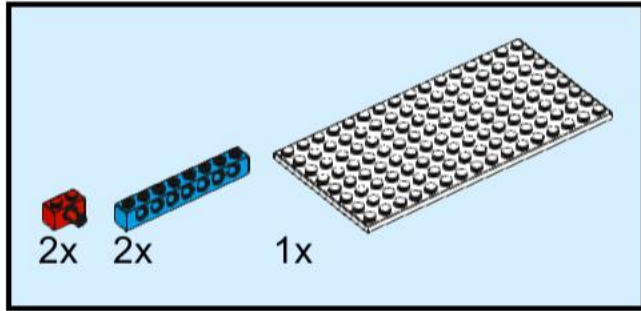

4

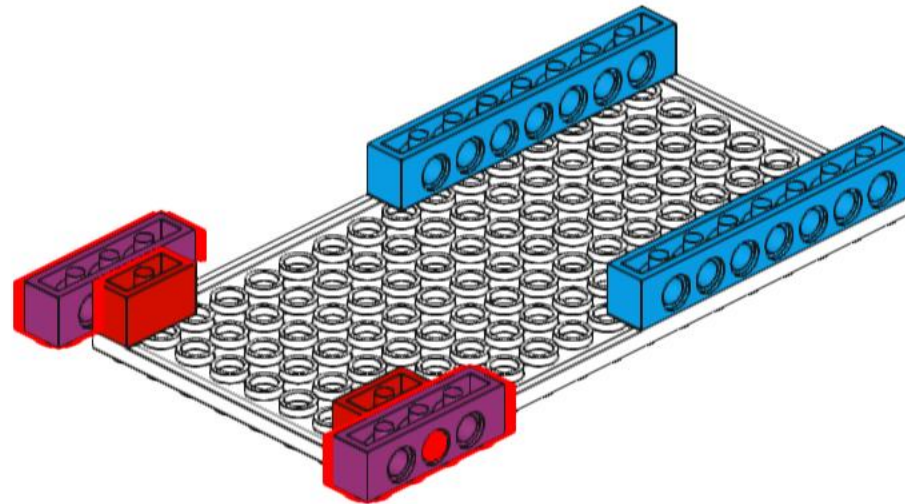
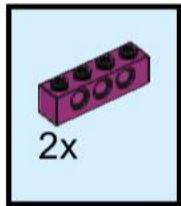

5

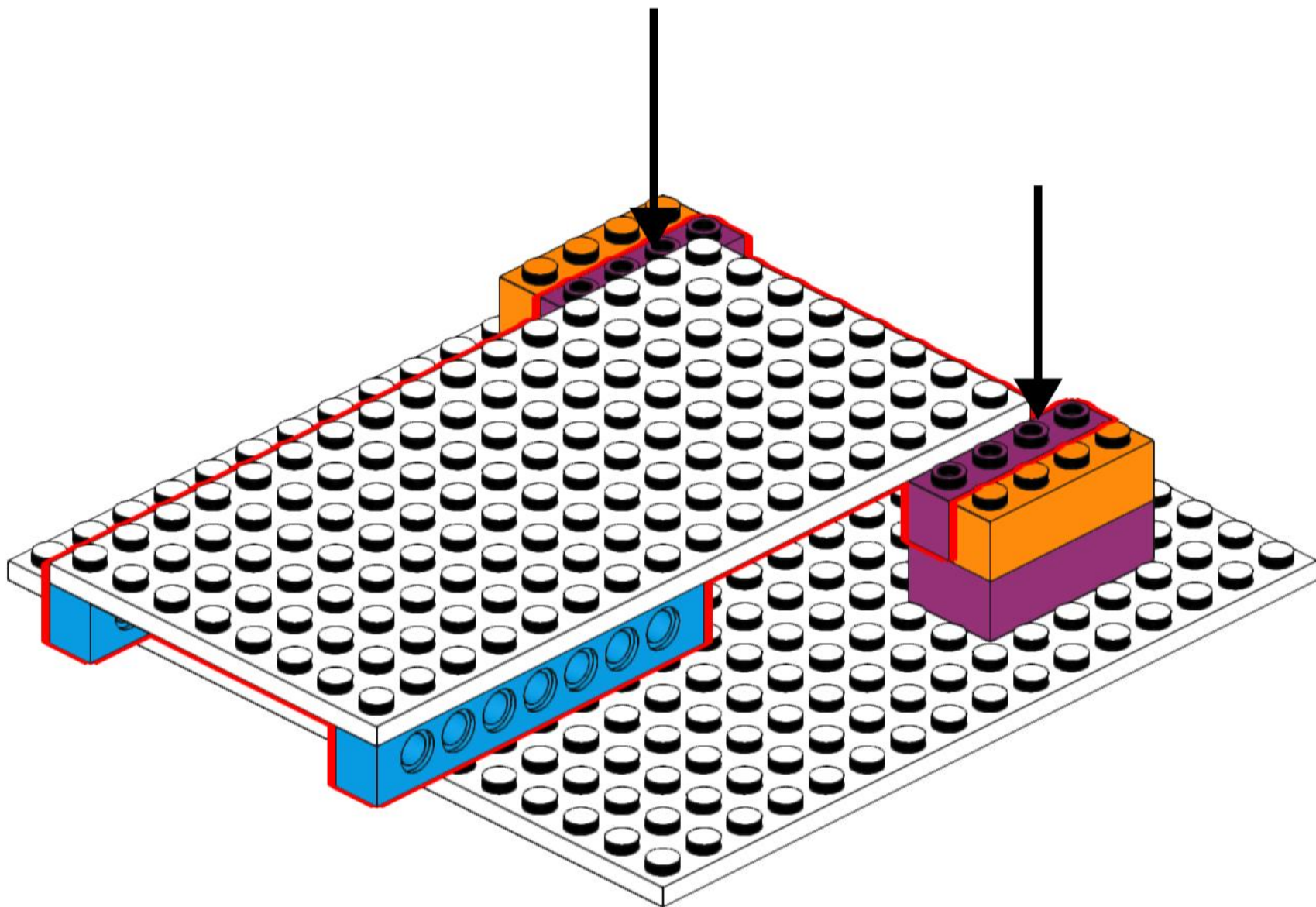

6

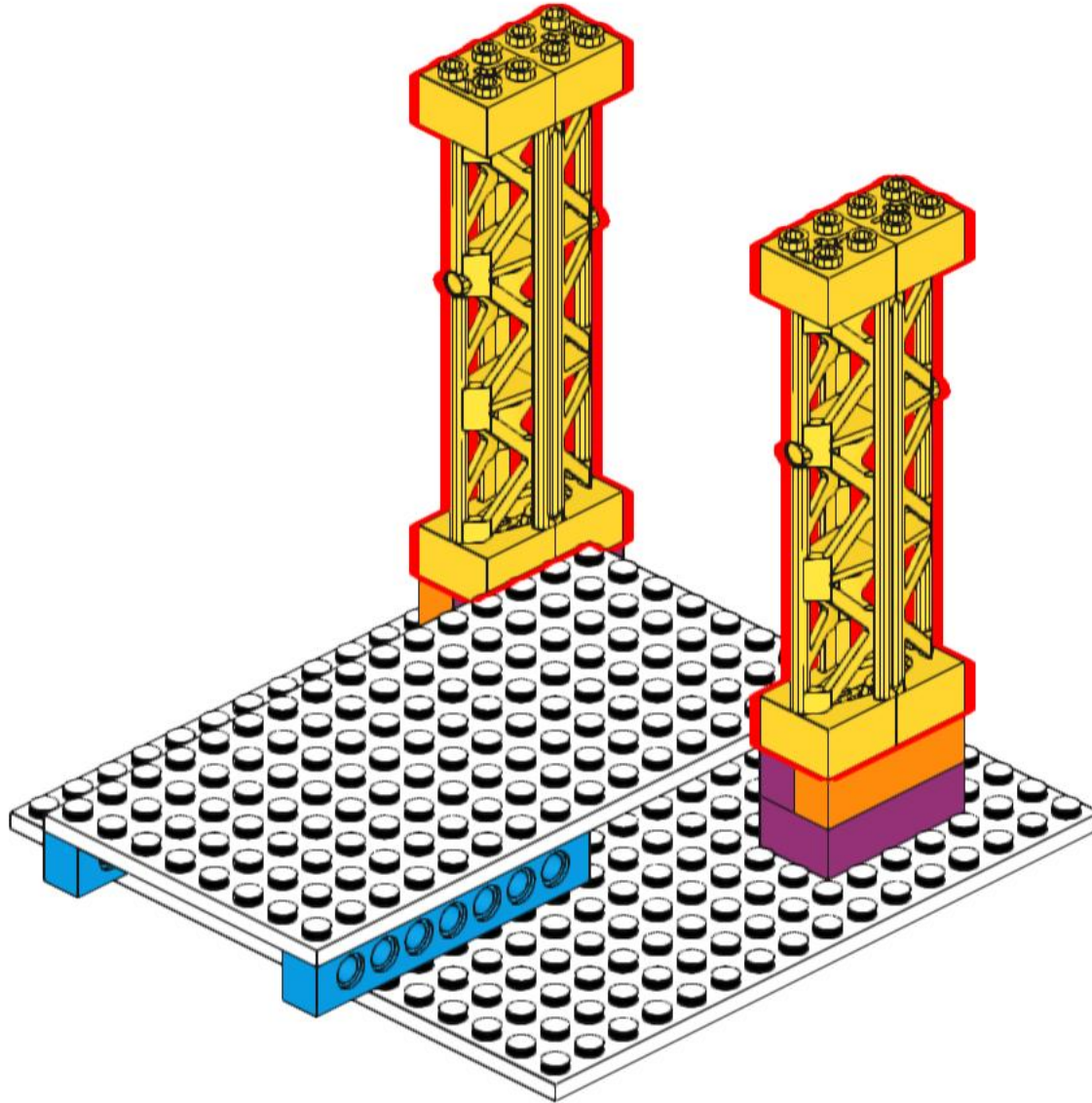
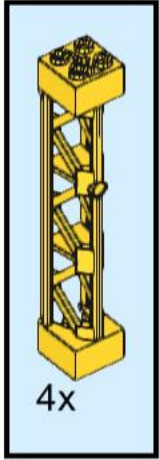

7

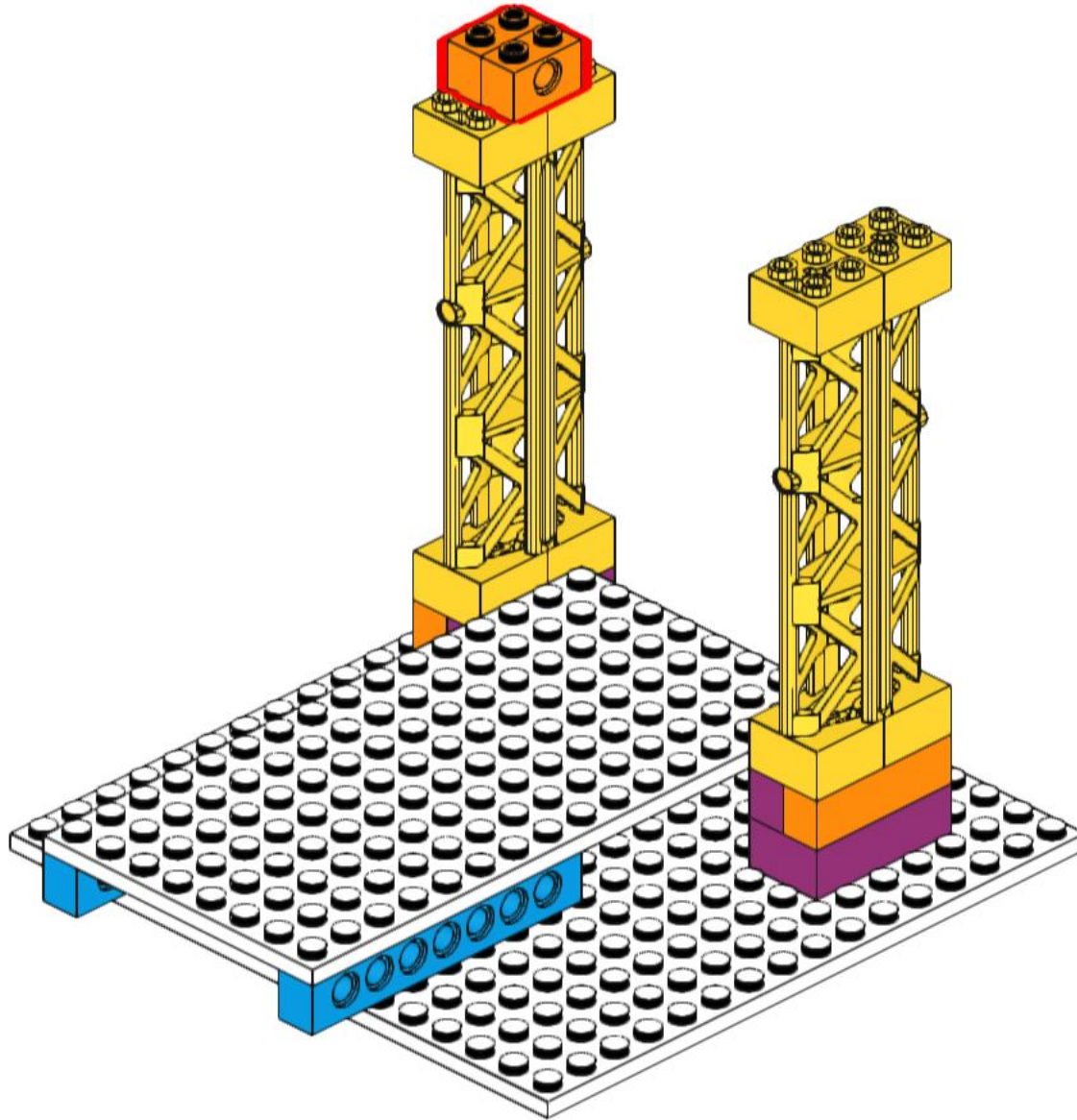
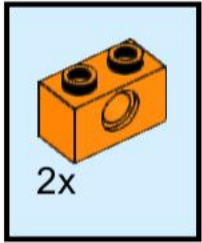

8

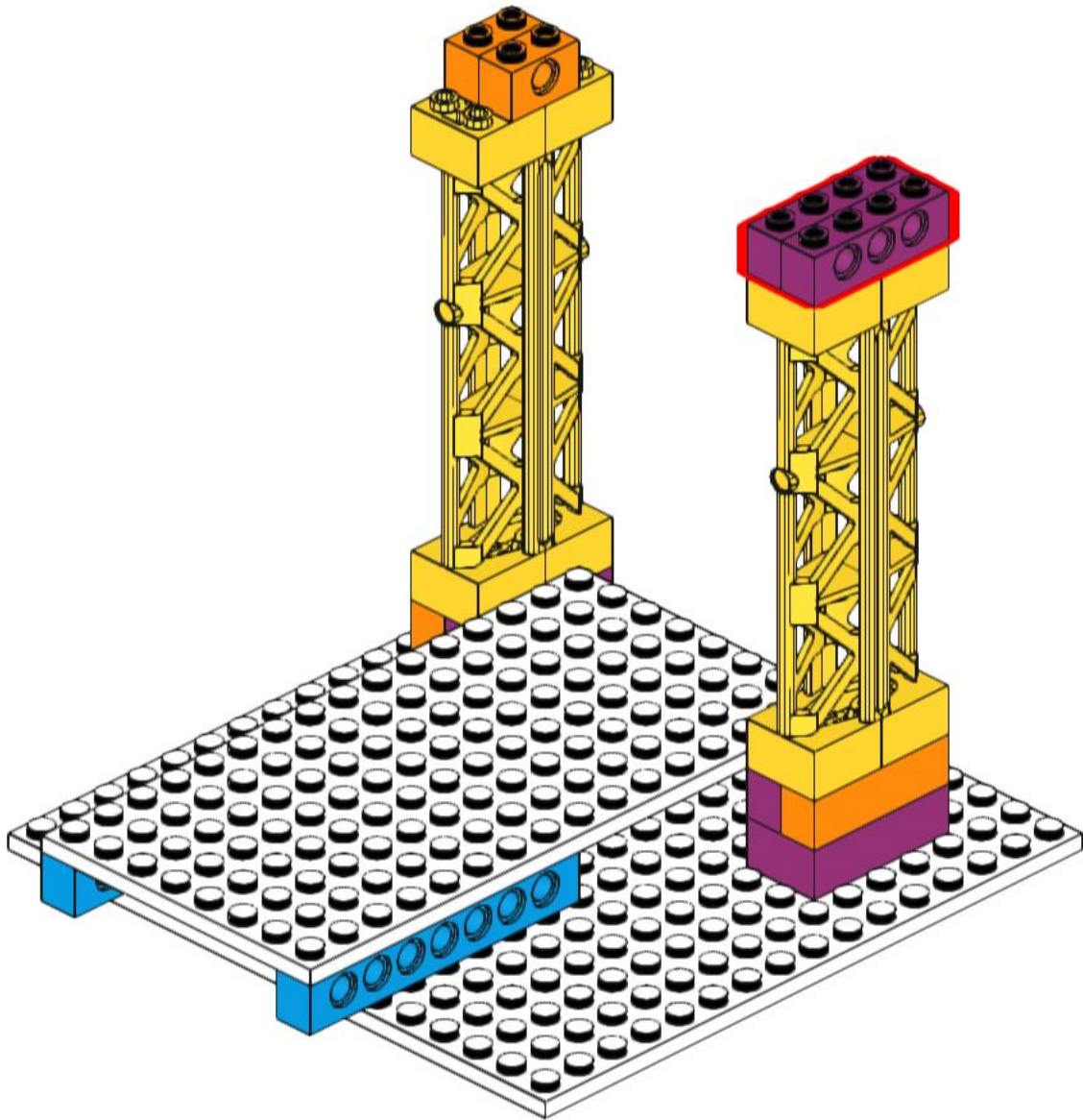
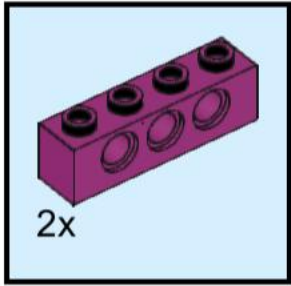

9

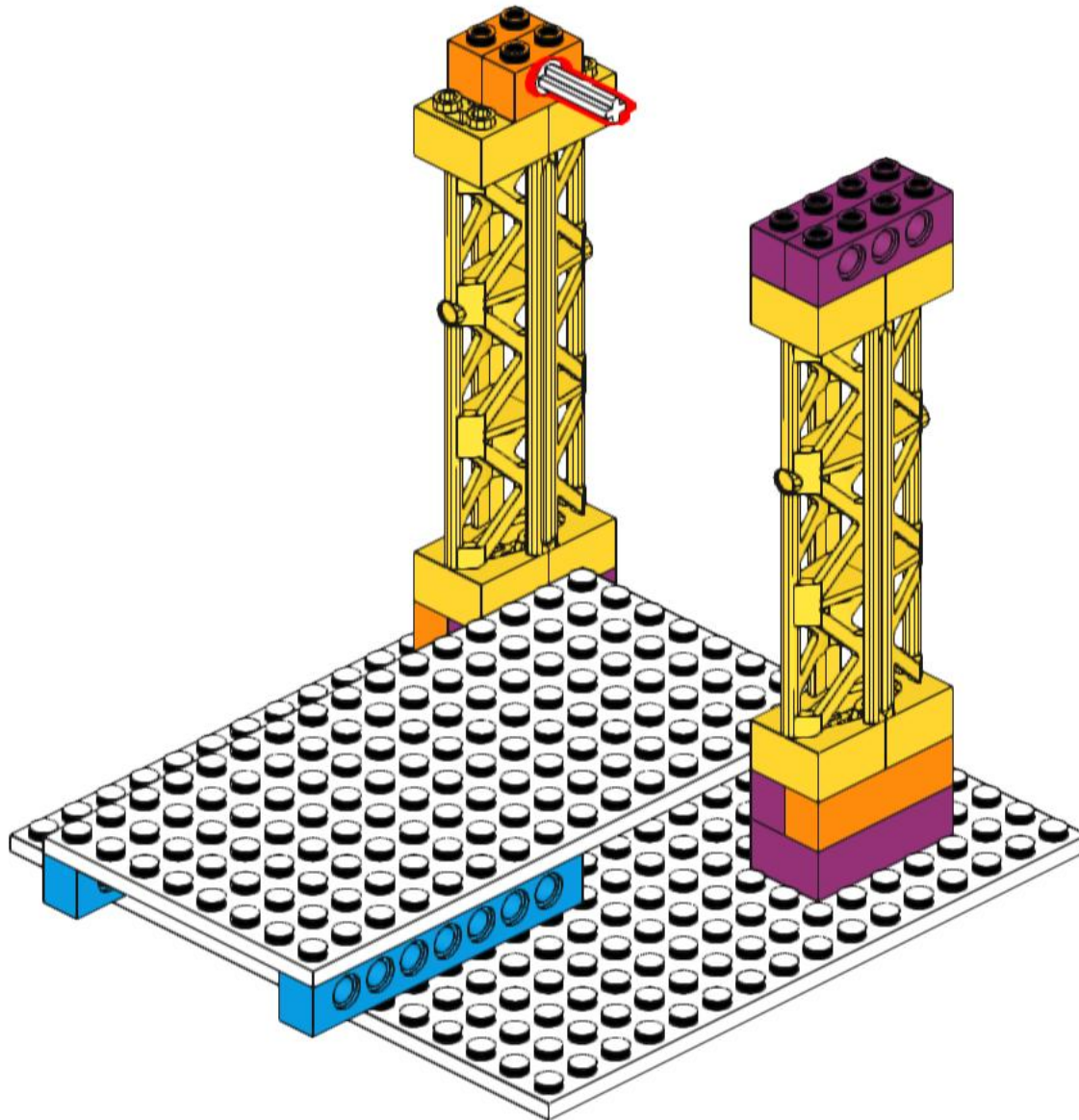
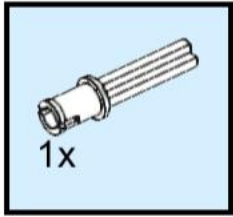

10

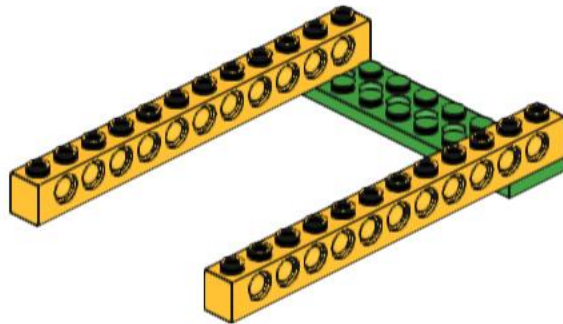
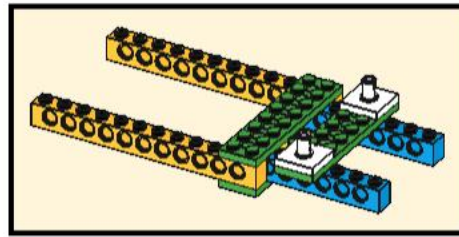
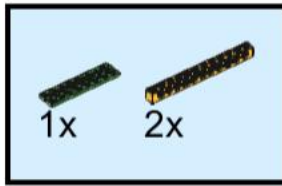

12

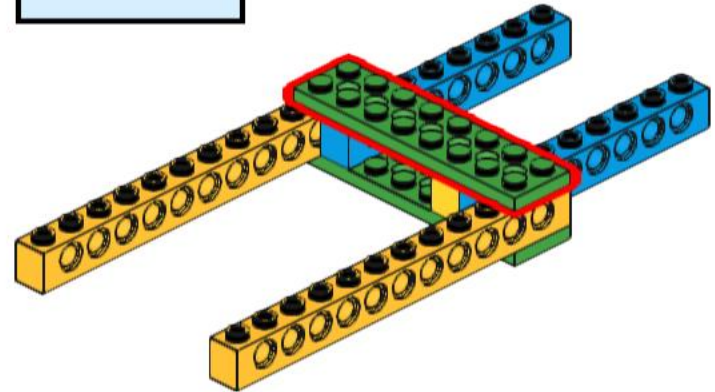
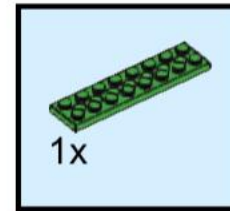

11

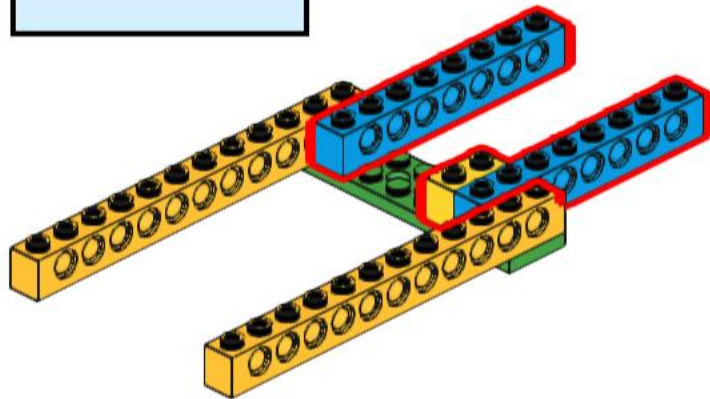
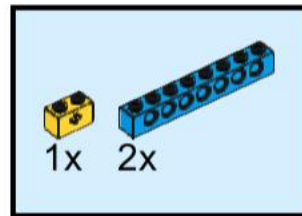

13

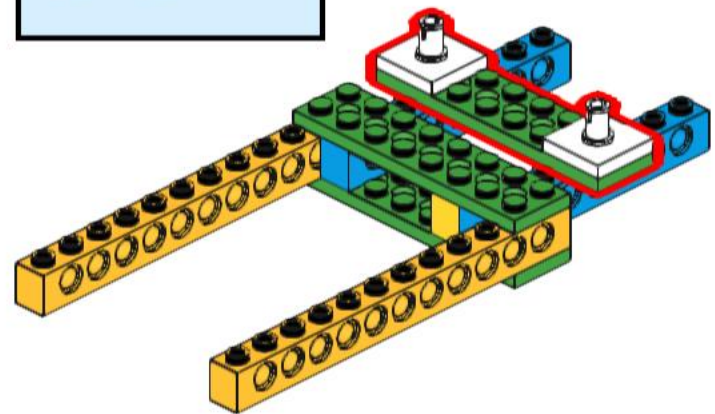
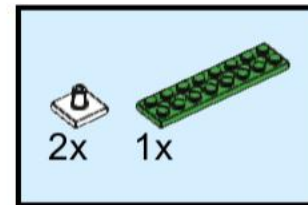

14

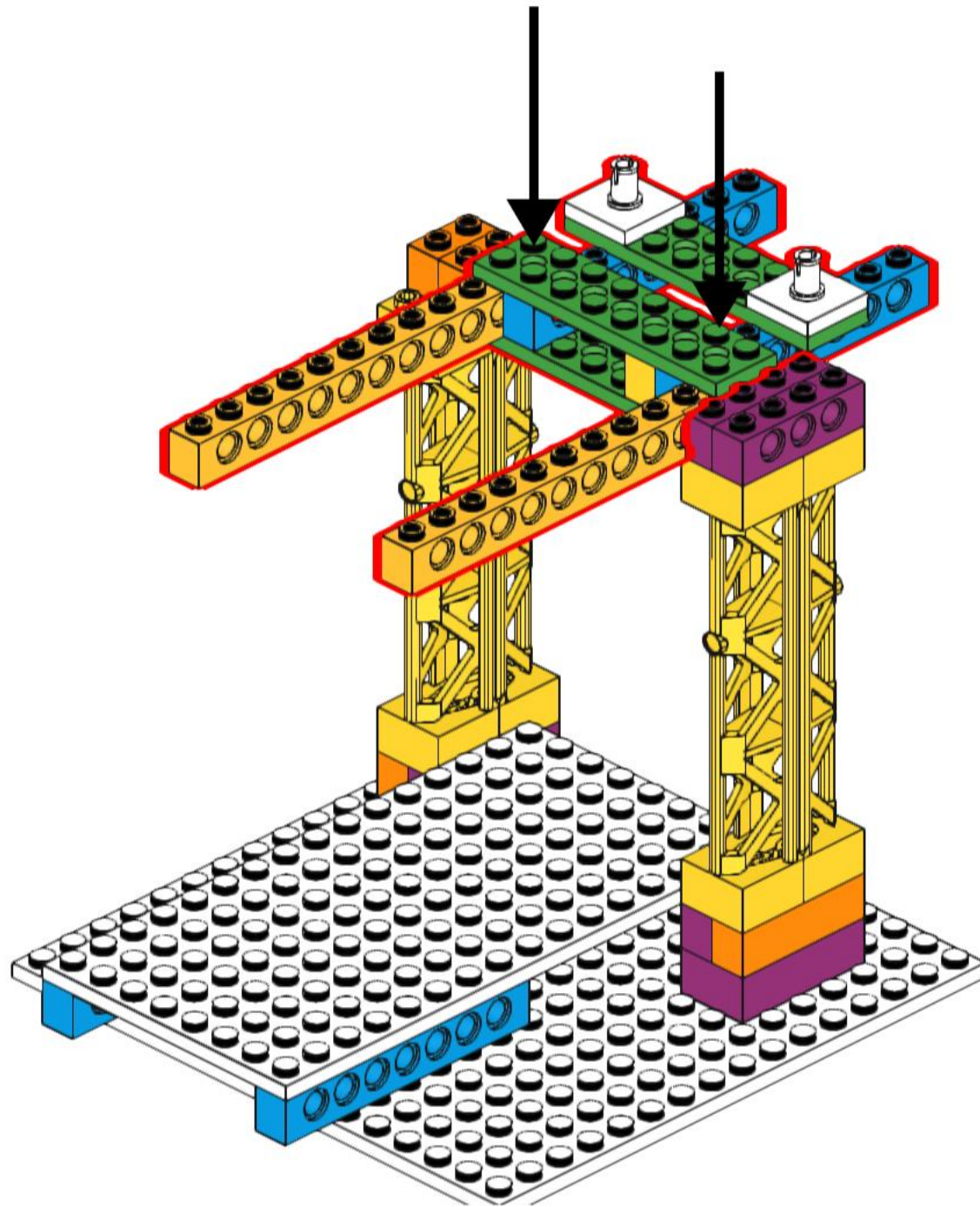

15

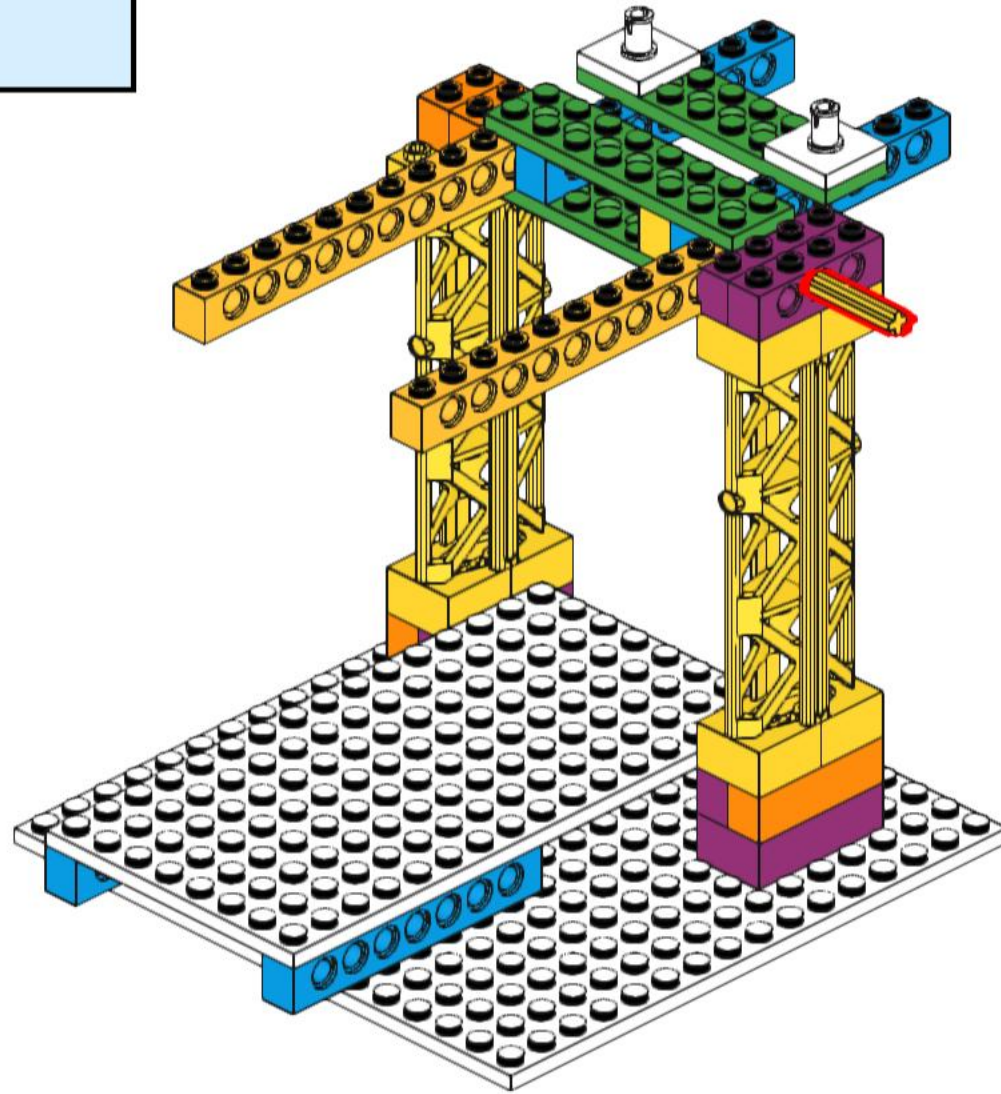
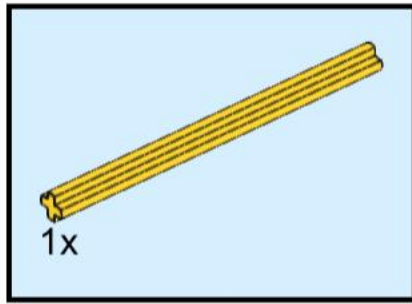

16

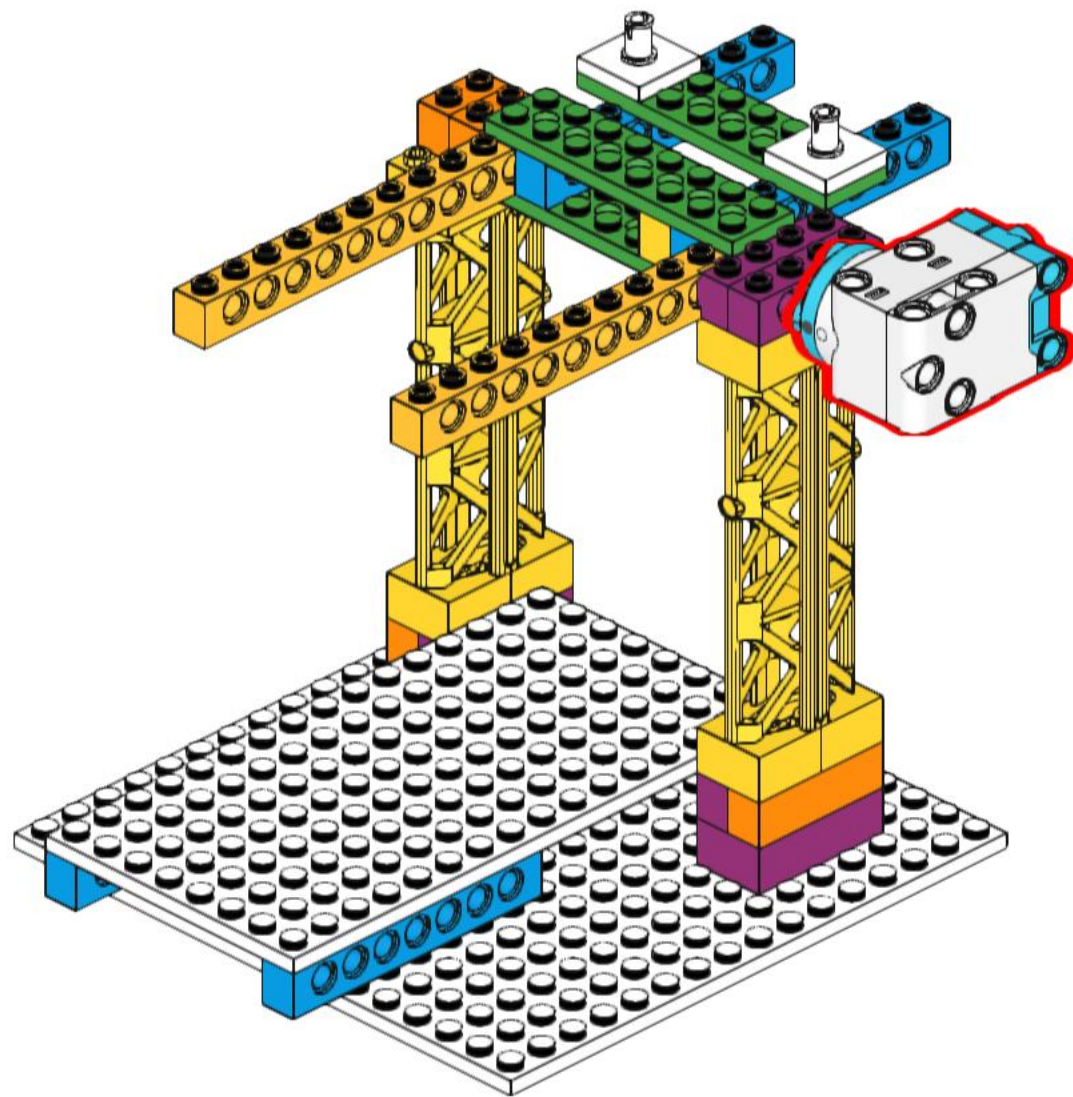
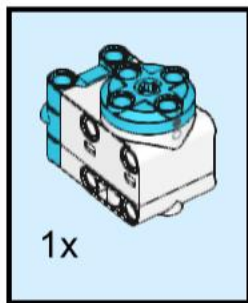

17

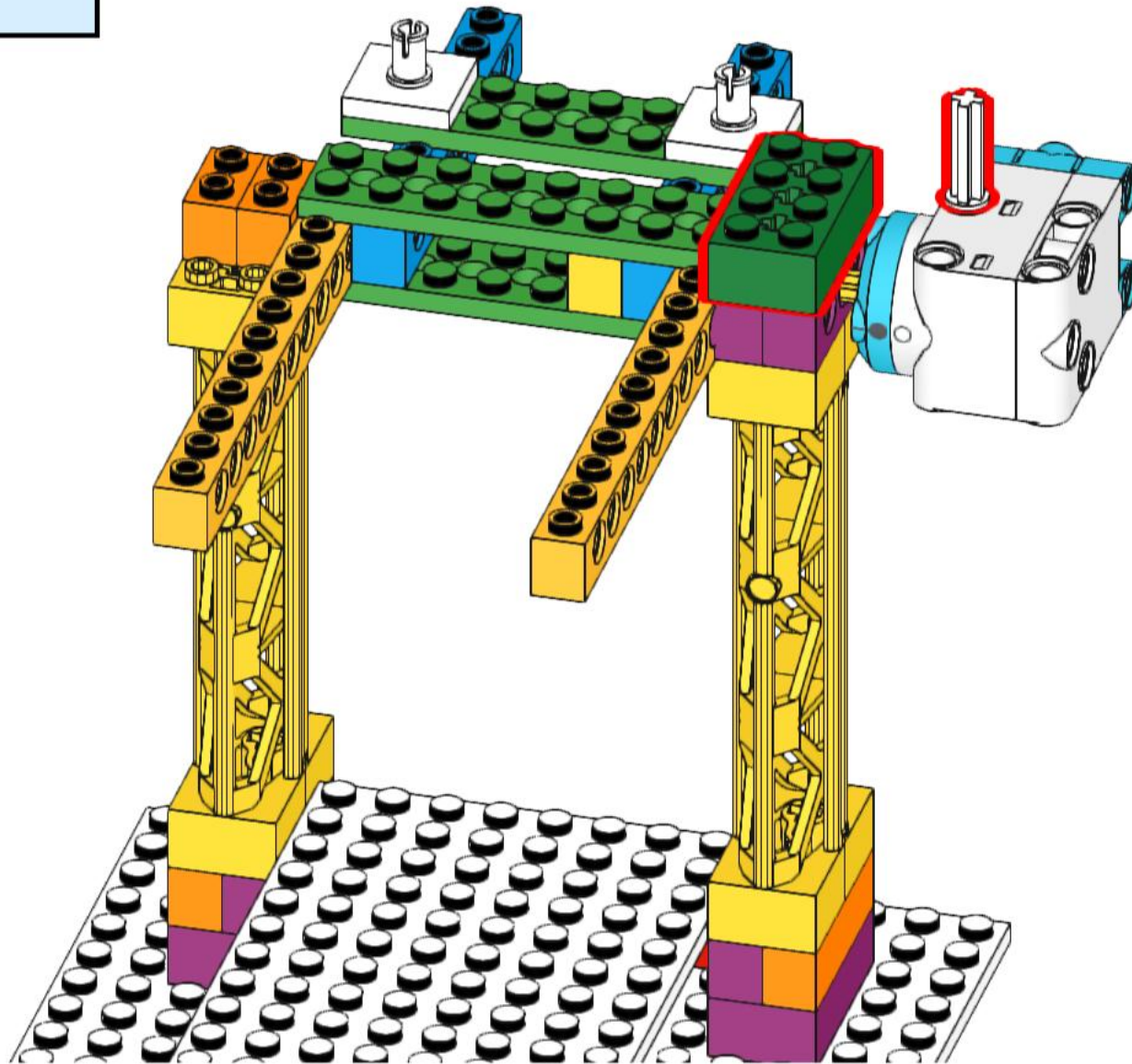
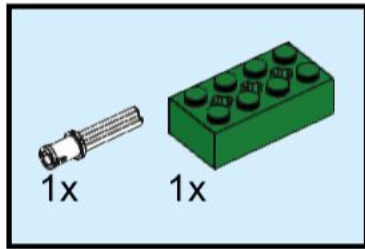

18

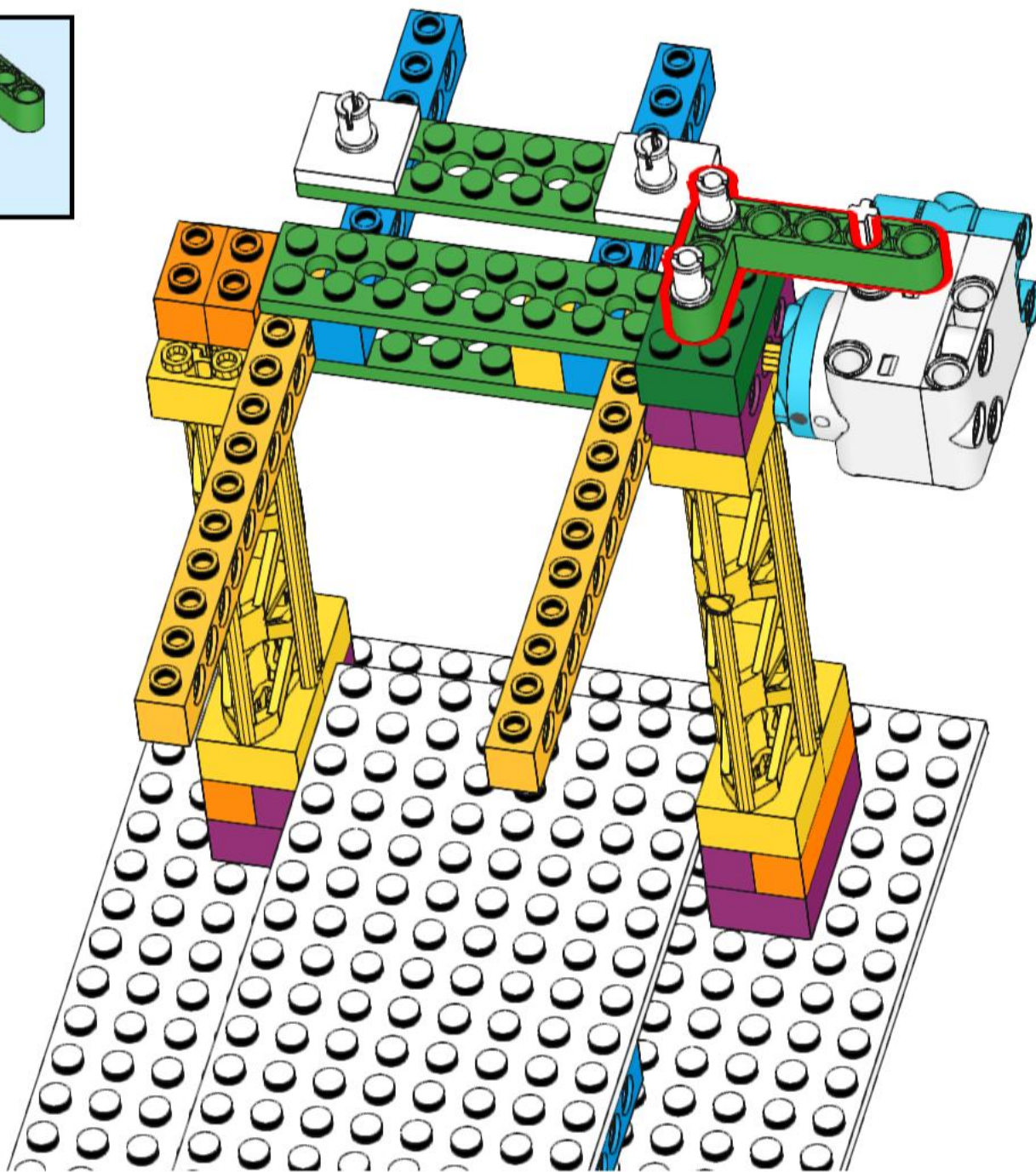
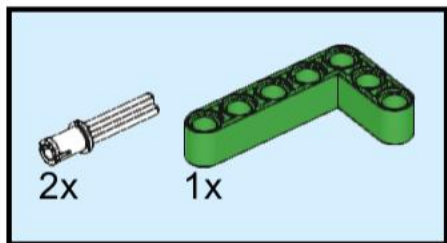

19

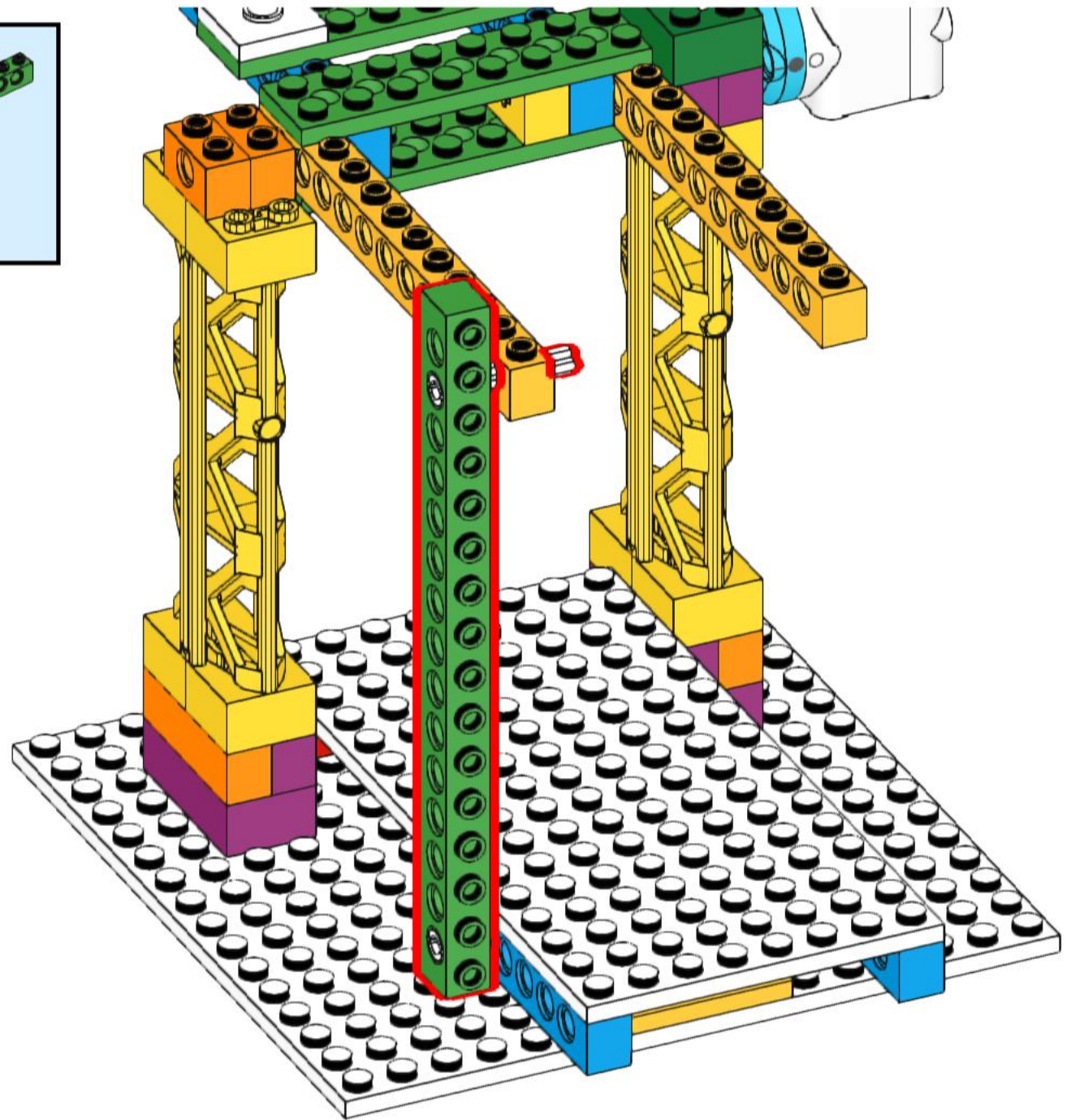
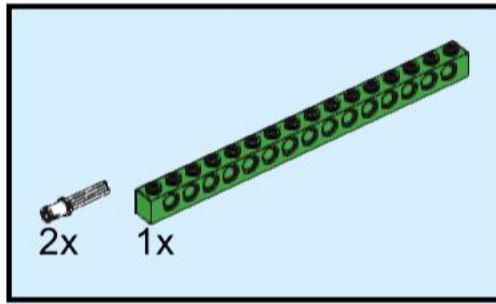

20

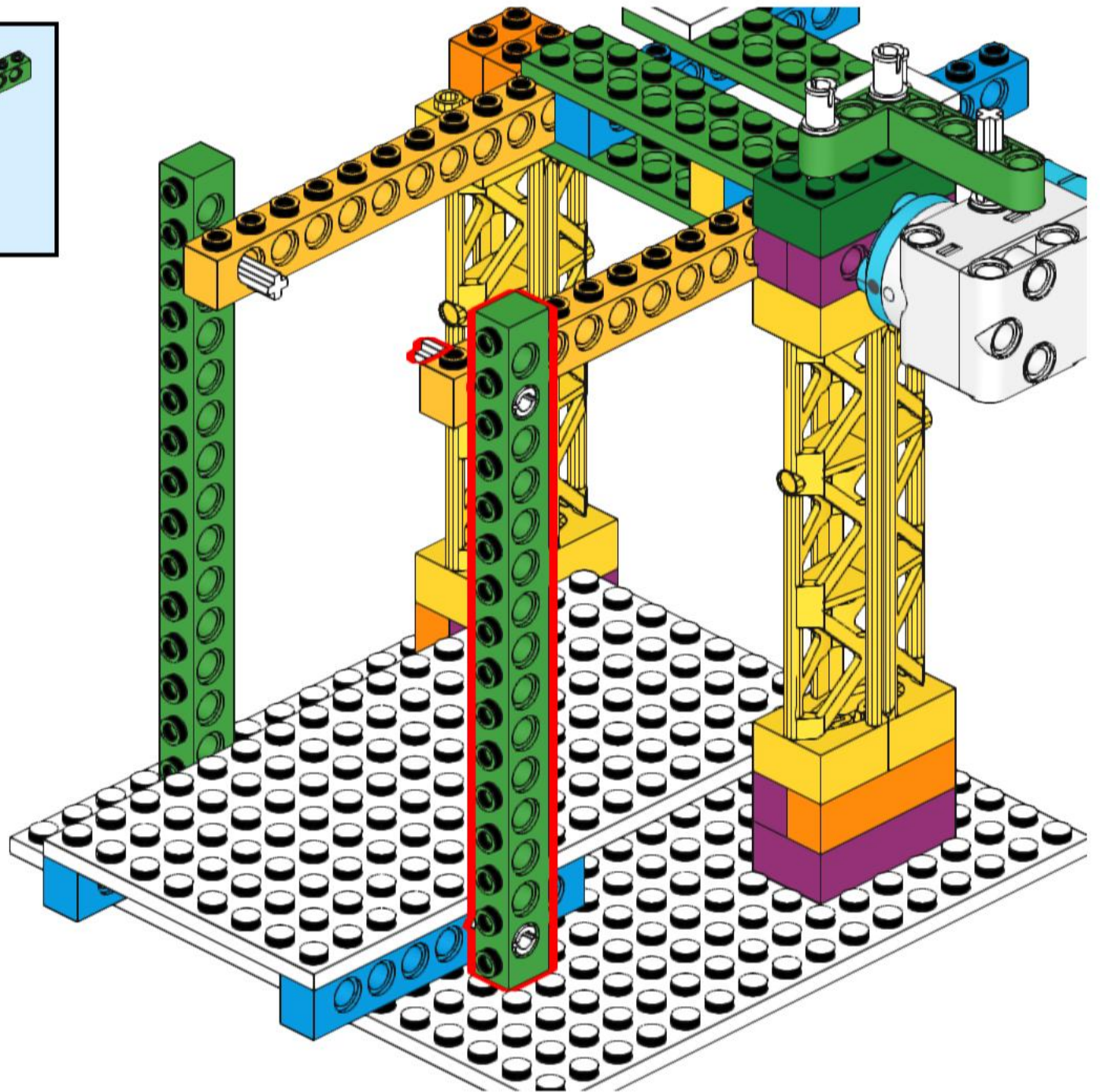
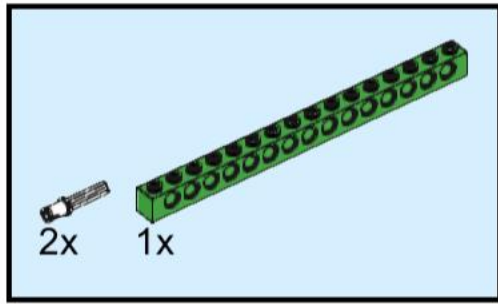

21

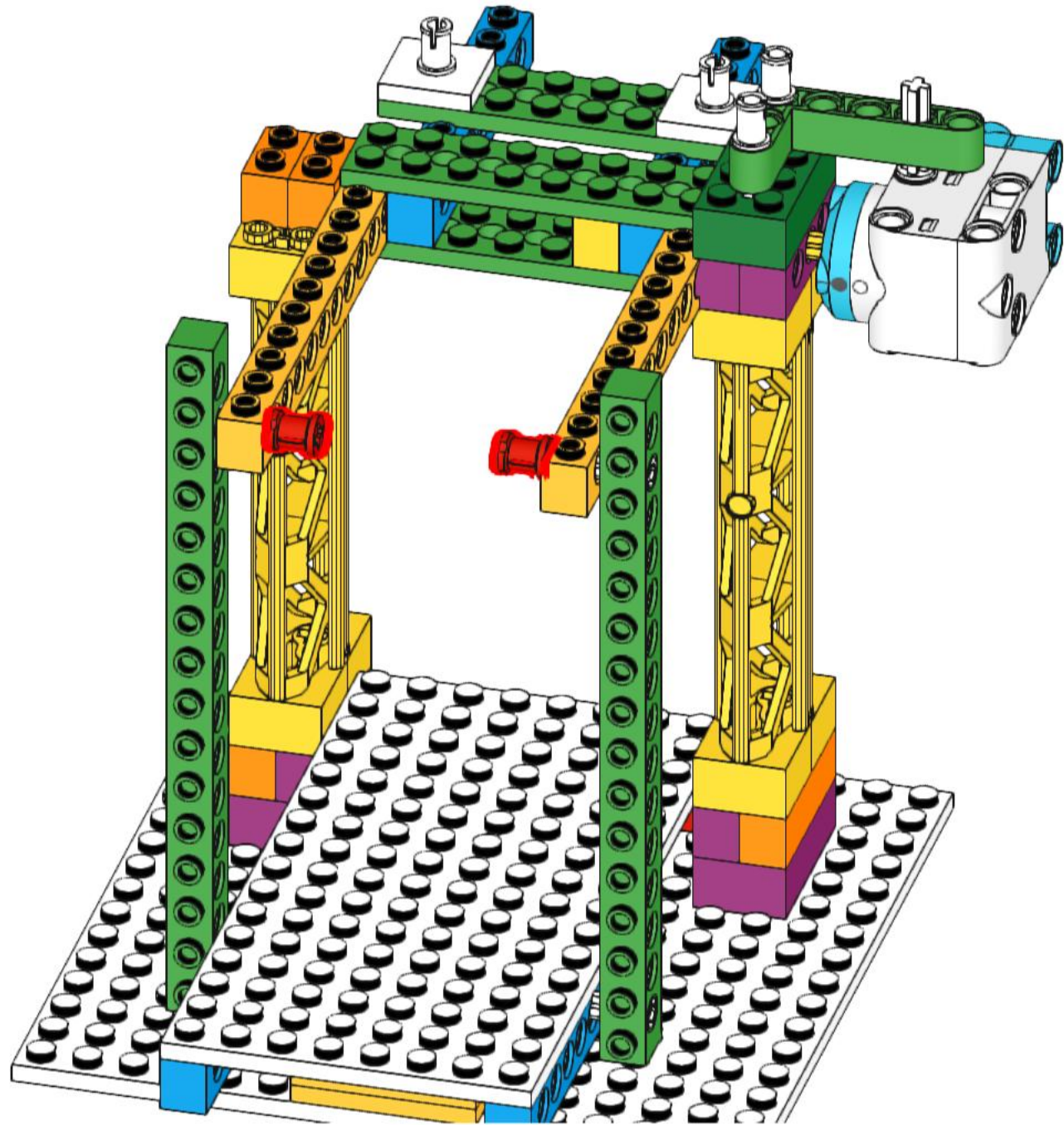

22

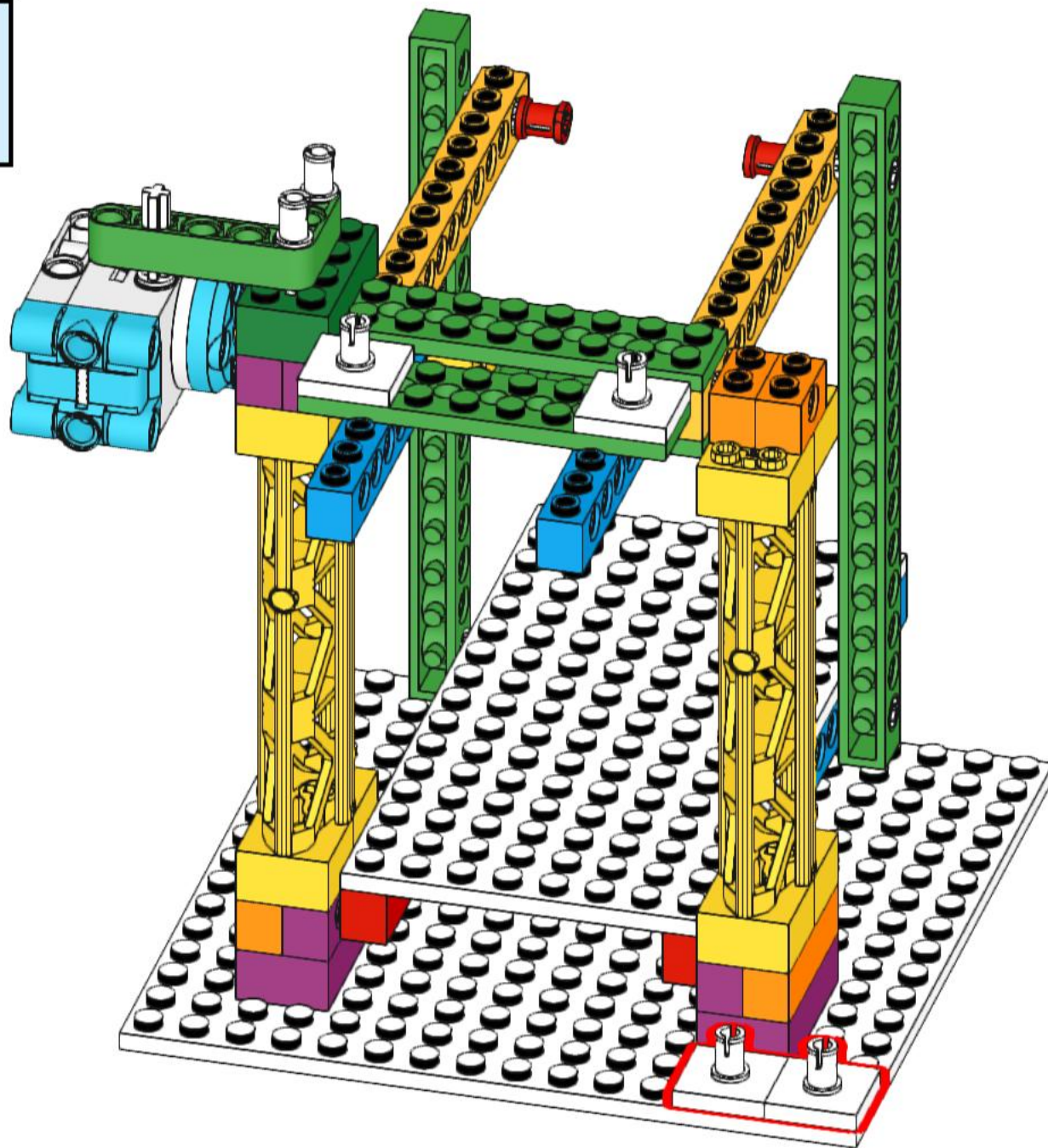
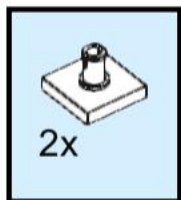

23

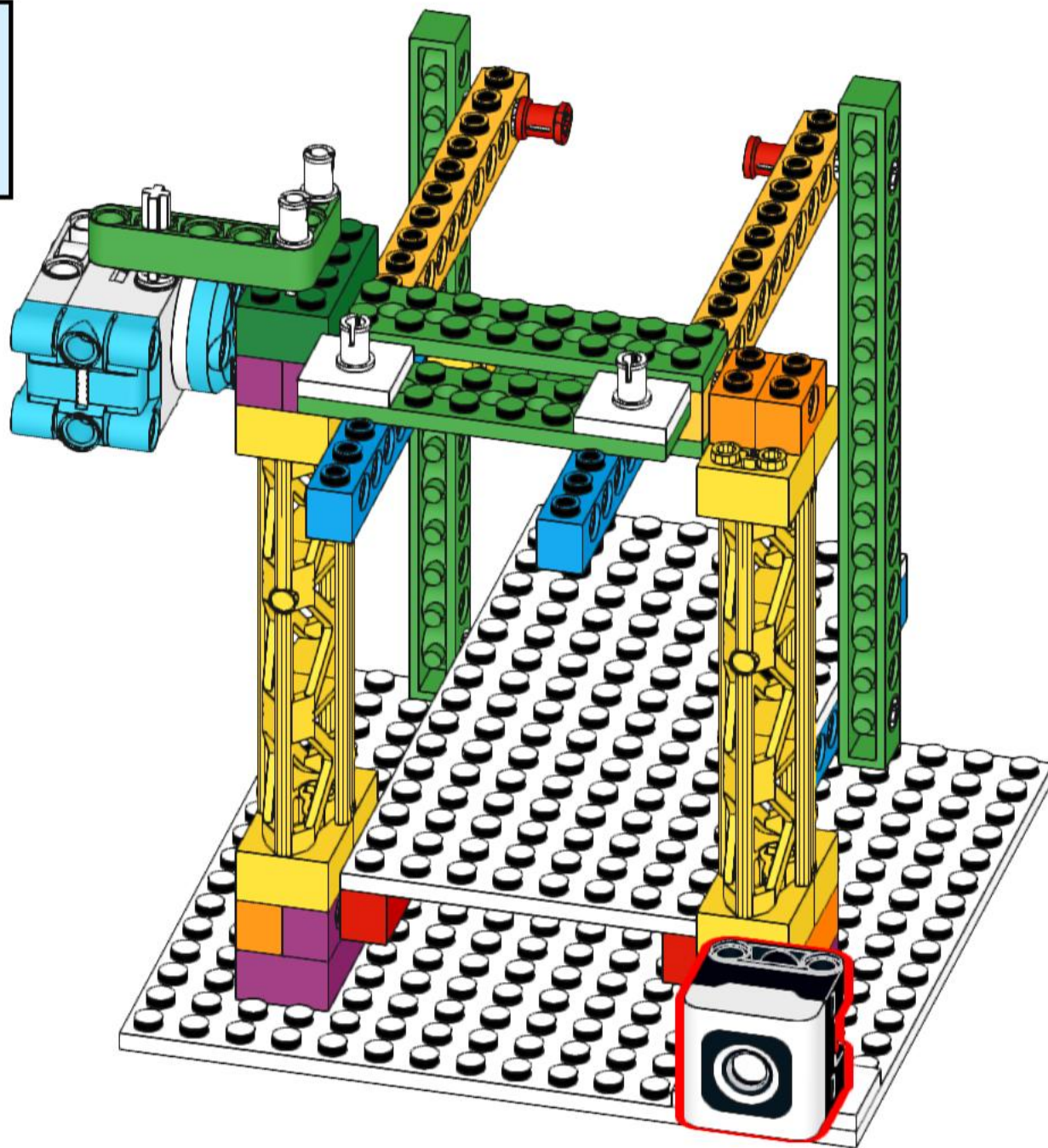
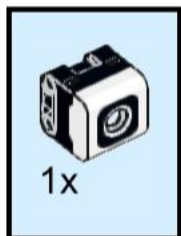

24

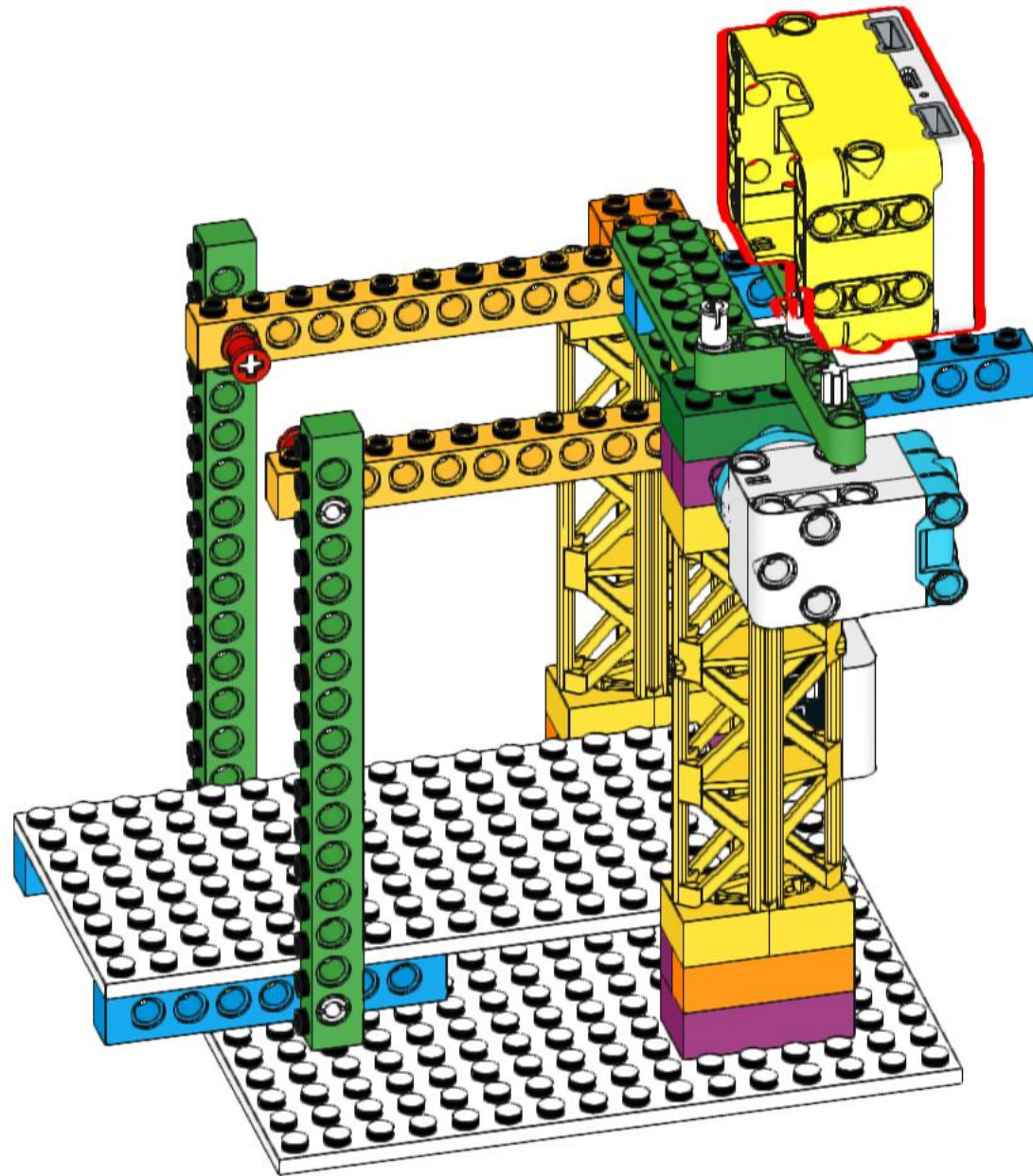
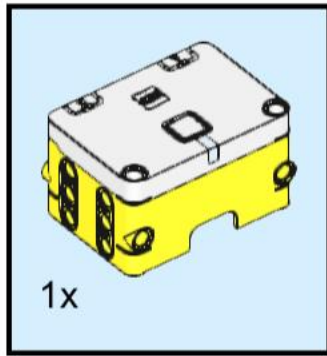

25

Klaar!

Sensor -> poort A
Motor -> poort B

